

Data Sheet



Article number: 2032100M24150A1U

Description: E+G levelling foot
GN 32-100-M24-150-A1-U

Note: U Without nut, Hexagon socket at the top, Wrench flat at the bottom

Measures

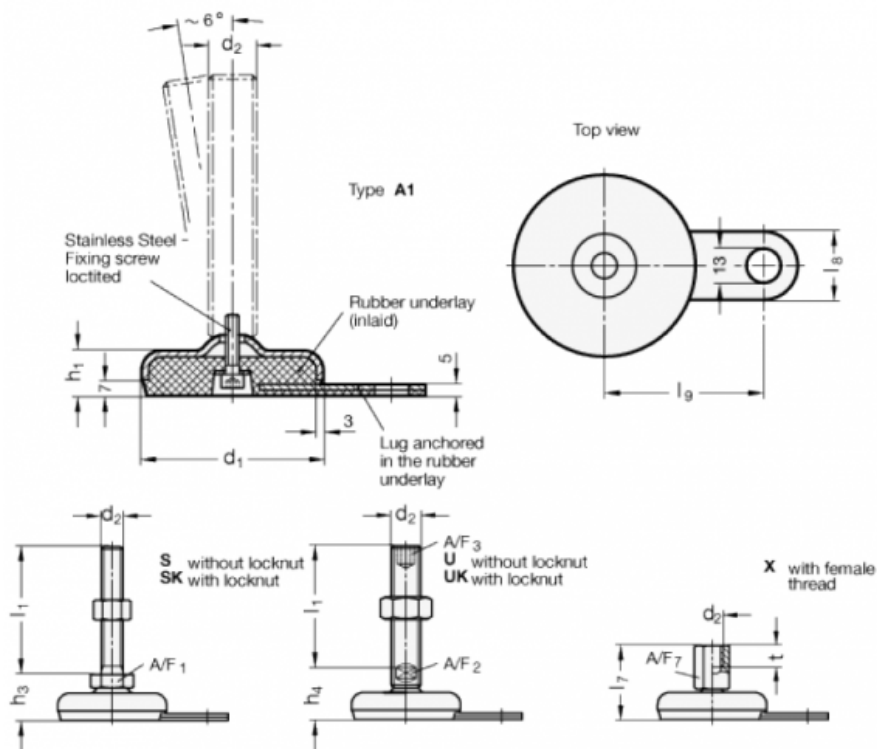

A/F2 = 19

l9 = 80

A/F3 = 12

d1 = 100

d2 = M24

h1 = 21

h4 = 39

l1 = 150

l8 = 30